

Vapogant

Digestate evaporation

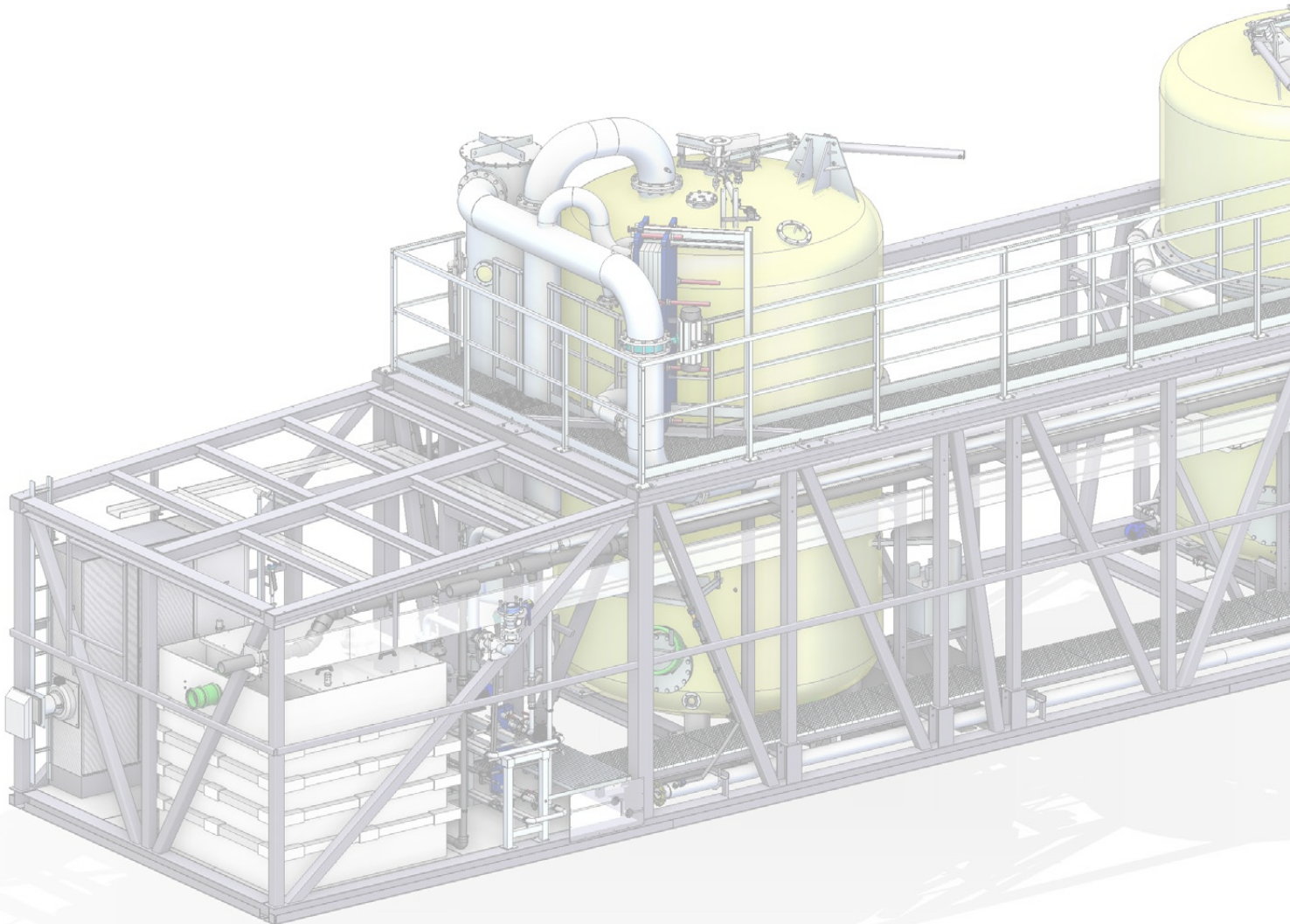

Scan QR-Code

for more information
and videos!



Digestate evaporation

Vapogant

Our plant treats the digestate of the biogas plant and produces a usable, concentrated fertiliser. We remove the water from the digestate through vacuum evaporation using waste heat from the CHPS. At the same time, volatile nitrogen is bound so that any emissions during spreading will be minimised, making the nitrogen available as ammonium sulphate solution (FarmAS). The goal is to use the available waste heat to thicken or enhance 100 % of the digestate produced in the biogas plant.

VAPOGANT DIGESTATE EVAPORATOR

Table of contents

What is Vapogant capable of?	4
Mass balance	8
Process description	9
Vapogant process concepts	10
Performance and heat data	12
Digestate evaporation	13
Products	14
Production of mineral fertiliser	15
Spreading/storage	16
Distillate use	18
Cooling system	19
Built-in technology	20
Layout	22

What is Vapogant capable of?

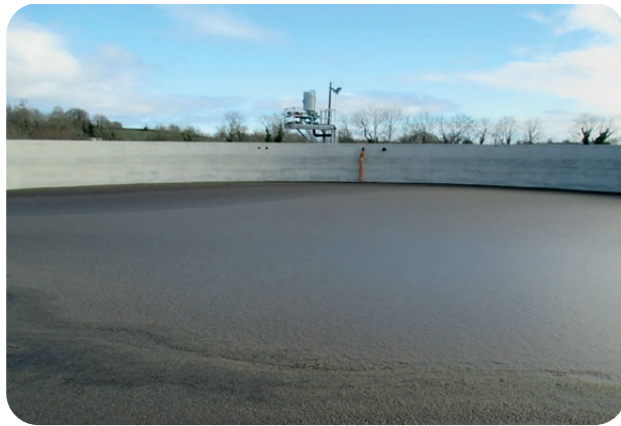

Storage

- ▶ The thickened digestate has much less volume and saves up to 70 % of digestate storage capacities
- ▶ Digestate evaporation as an alternative to building additional digestate storages
- ▶ No additional digestate storage problem due to the amended ordinance on installations that handle substances hazardous to water (VAWS) and the fertilisation ordinance
- ▶ Enormous thickening of the liquid phase
- ▶ Possibly no Hazardous Incident Ordinance requirements



Transport

- ▶ Reduced volume means fewer drives (less impact on roads and population)
- ▶ Fewer passes over fields due to concentrated nutrients
- ▶ The weather risk is reduced, and the impact of spreading increased



Emissions

- ▶ 100 % closed system
- ▶ Full condensate treatment
- ▶ No odours
- ▶ No exhaust gases
- ▶ No noise (60 dB in 10 m)
- ▶ No particulate matter
- ▶ Vacuum pump recirculates exhaust gas to the gas system of the biogas plant or activated carbon filter

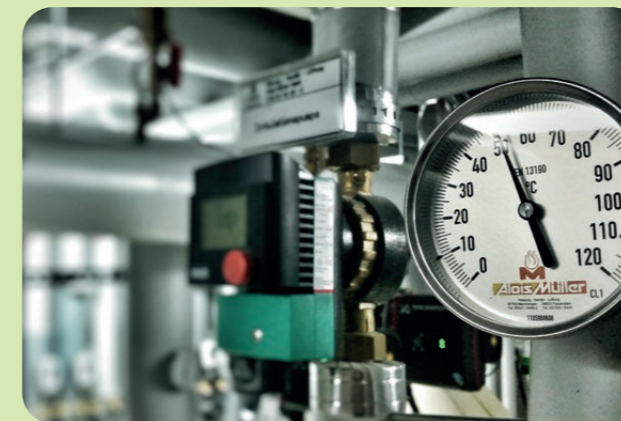

Heat use

- ▶ Efficient heat use throughout the year
- ▶ CHP bonus guaranteed due to efficient fertiliser production
- ▶ Integrates easily with existing plants (also for partial heat use)
- ▶ Multiple use (multi-stage) due to vacuum system
- ▶ Heat recovery: 1. Evaporation 2. Digester heating
- ▶ Automatically controlled 100 % utilisation of heat



Nutrient management

- ▶ Use of nitrogen fertiliser exceeding the 170 kg N limit possible
- ▶ Very low N losses during storage and spreading
- ▶ Upgrading the digestate to ammonium sulphate solution (farmAS®) that can be transported and concentrated fertiliser (farmLC®)
- ▶ Less nitrogen loss through ammonia emissions on the field, hence savings in purchasing nitrogen
- ▶ Improved nutrient management: Thanks to the separate nutrient fractions, nutrients can be applied much more selectively and efficiently.



Spreading/fertilisation

- ▶ Top-class nutrient management
- ▶ Increased nutrient concentration:
 - Lower weather risk
 - Less driving
 - Maximum effectiveness
- ▶ Nitrogen losses are very low
- ▶ Substantial reduction of fertiliser purchase
- ▶ Additional benefit through sulphur fertilisation

FarmLC (liquid compost)

Ideal CN ratio

In high-yield soil, a C-N ratio of 20:1 is desired. Accordingly, the optimum C-N ratio in the fertiliser applied is also 20:1. Our FarmLC from the Vapogant has a C-N ratio of 10:1 and therefore comes very close to the ideal fertiliser.

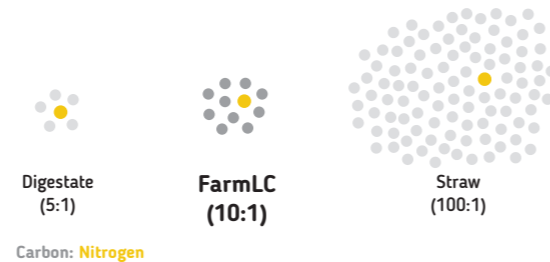

Operational challenges – problem solved!

- ✓ Spreading close to the ground without problems
- ✓ Fertilisation ordinance (nitrogen and phosphorus balance)
- ✓ No additional purchase of e.g. ASS, but sale of Farm AS®
- ✓ **Profitable and environmentally friendly circular economy**

Exemplary representation of the material flows with Vapogant and Sepogant Direct with inclined pump

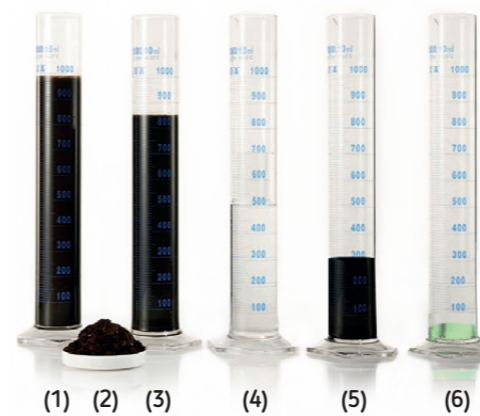
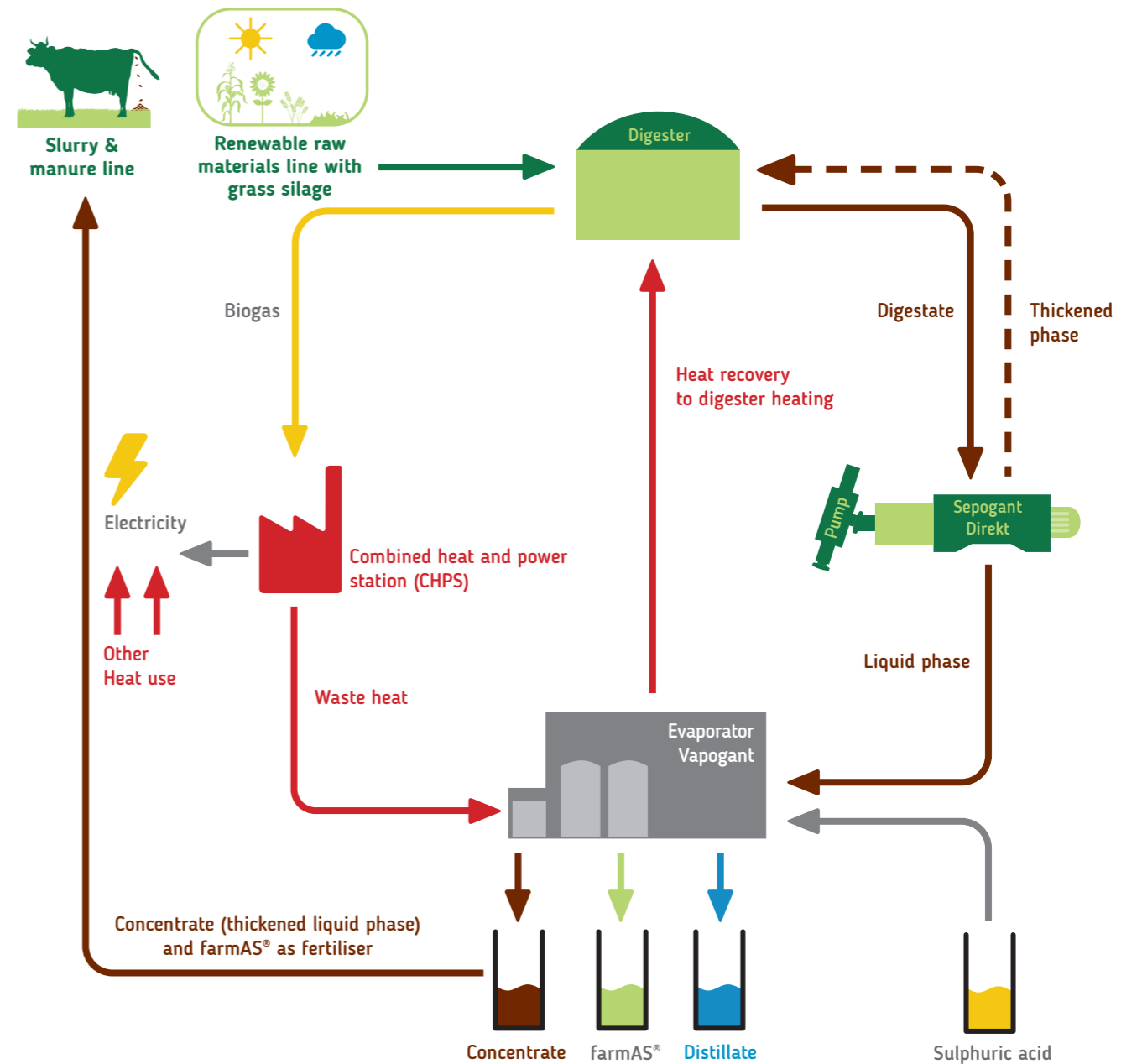

Composition of the digestate

- 1) Digestate from digester
- 2) Solid material obtained by separation
- 3) Liquid phase after separation
- 4) Distillate: the water removed from the digestate for introduction, evaporation or use as process water
- 5) Liquid phase as concentrate (farmLC)
- 6) Ammonium sulphate solution (farmAS®)

Mass balance

Reference values from the mass balance of digestate evaporation at different heat consumption levels

Heat:	500 kW	
Digestate/ wastewater	36 m ³ /d	12,500 m ³ /a
Solid matter:	4.56 m ³ /d	1,600 m ³ /a
Concentrate:	6.96 m ³ /d	2,400 m ³ /a
Distillate:	22.8 m ³ /d	7,900 m ³ /a
farmAS [®] :	1248 l/d	433 m ³ /a
Sulphuric acid:	312 kg/d	108 t/a

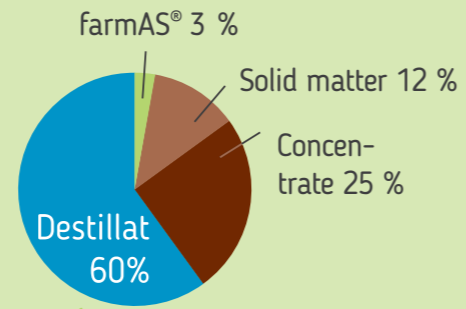

Digestate storage requirement Liquid 28 %



Liquid digestate storage requirements 100 %

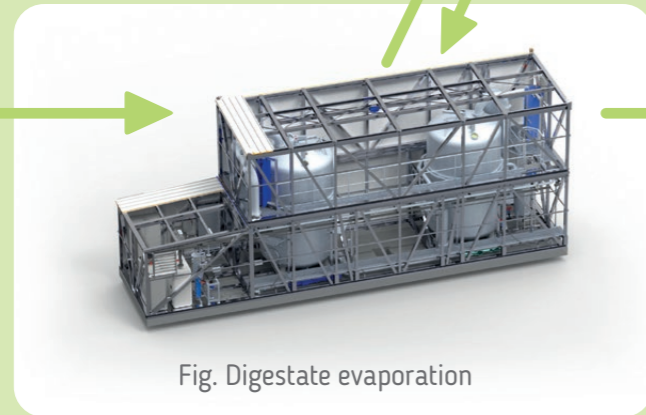

Fig. Digestate evaporation

Vapogant process description: Thickening and vapour cleaning

Digestate evaporation is preceded by mechanical separation, during which the digestate passes through a fine-mesh screen (e.g. 0.5 mm) and is separated into a liquid and a solid phase.

The solid matter (solid phase) is put out in a suitable area for intermediate storage and can be used for targeted fertilisation as needed. During the time when no fertiliser is spread, it can be stored in open areas or in bunker silos. The liquid phase is introduced into the process of digestate evaporation.

Inside the plant, the liquid phase is heated and put under a vacuum. In this step, part of the liquid phase evaporates, thereby thickening and concentrating the digestate. This step is repeated in another evaporator where heat recovery enables energy-efficient evaporation and multiple heat use.

Inside the vapour cleaner, the gas phase that is produced through heat and vacuum is stripped of ammonia by adding sulphuric acid. In this process, ammonia is converted into ammonium sulphate and concentrated. The ammonium sulphate solution (farmAS[®]) can be stored in separate containers.

The vapour produced in this process, which has been stripped of ammonia, is condensed to water (distillate) in heat exchangers, and the recovered heat is used. The distillate is transported to storage tanks for intermediate

storage. After the distillate has cooled down in the dry or wet cooling tower, it is used as a cooling liquid e.g. in the condenser heat exchangers. The plant is sealed hermetically, resulting in a low-emission process.

A vacuum pump generates the vacuum required for energy-efficient evaporation. This pump is connected at the pressure side of the gas compartment of the biogas plant; thus, residual gases emerging from the liquid phase are safely fed back into the biogas plant. There, they are either metabolised microbially (e.g. H₂S that is converted into sulphur) or burnt in the CHPS (CH₄).

At the end of the process, the concentrate (the thickened liquid phase of the digestate) exits the process under vacuum. This digestate is now concentrated and contains all nutrients also found in untreated, non-dried digestate – with the exception of ammonia. This highly volatile substance is concentrated in the form of ammonium sulphate solution (farmAS[®]). farmAS[®] is subsequently stored in one or more separate tanks.

Evaporation capacity of the plant

The digestate evaporator has a modular design. The evaporation capacity is up to 2.5 litres per kW_{therm}, depending on the flow temperature, temperature difference and dry matter content in the inlet and outlet of the plant.

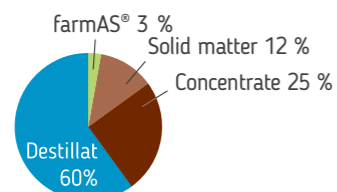

Example of a 500 kW system with **normal separator**:
farmAS[®] 3 %, distillate 60 %, concentrate 25 %, Solid matter 12 %

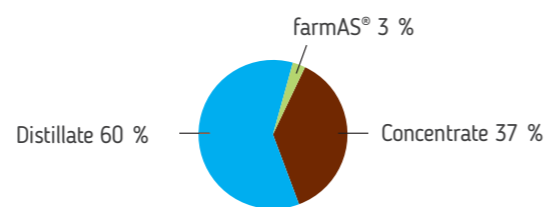

Example of a 500 kW system with **Sepogant Direkt**:
farmAS[®] 3 %, distillate 60 %, concentrate 37 %



Process concept of the Vapogant digestate evaporation

1-stage

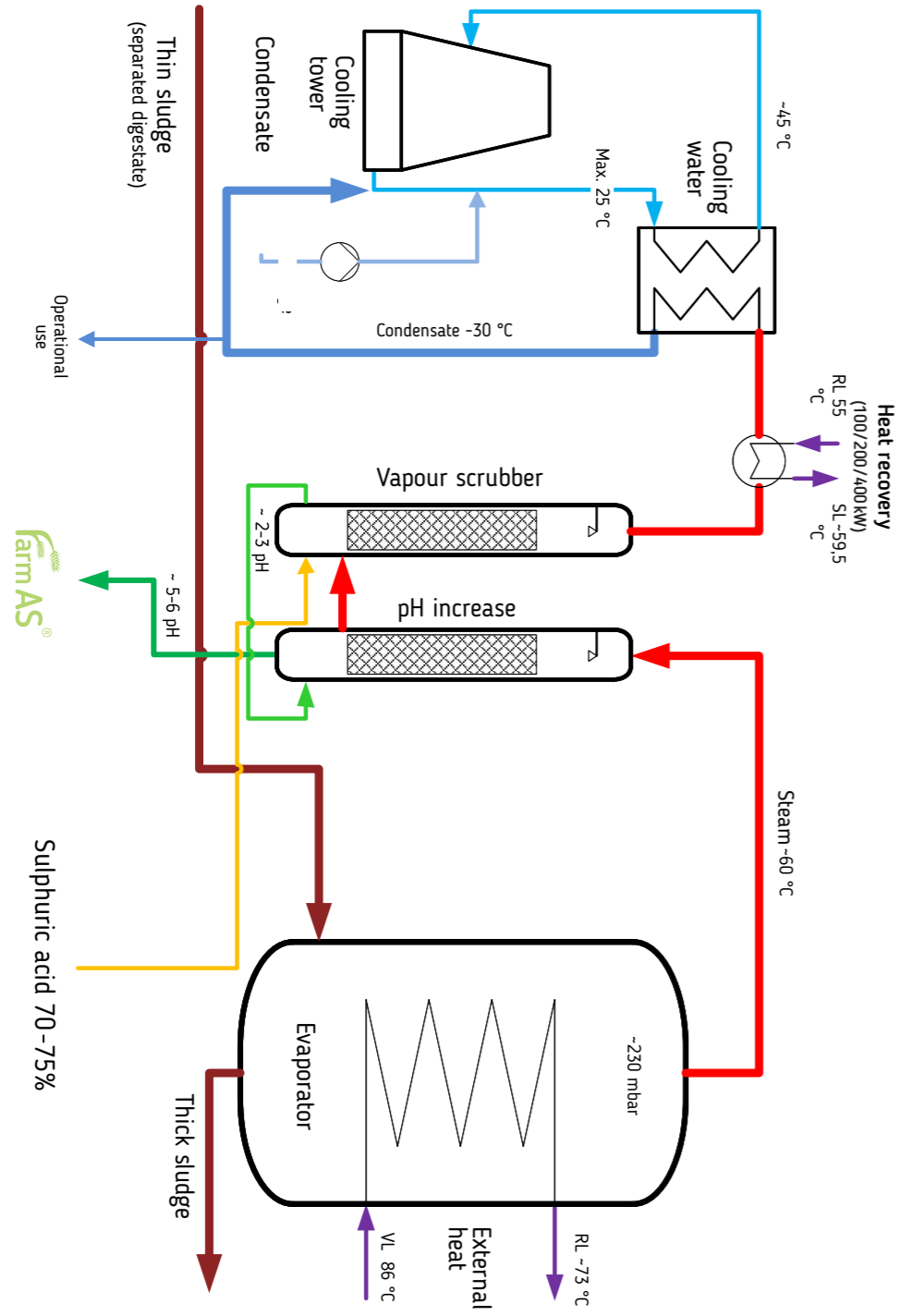

Process concept of the Vapogant digestate evaporation

2-stage

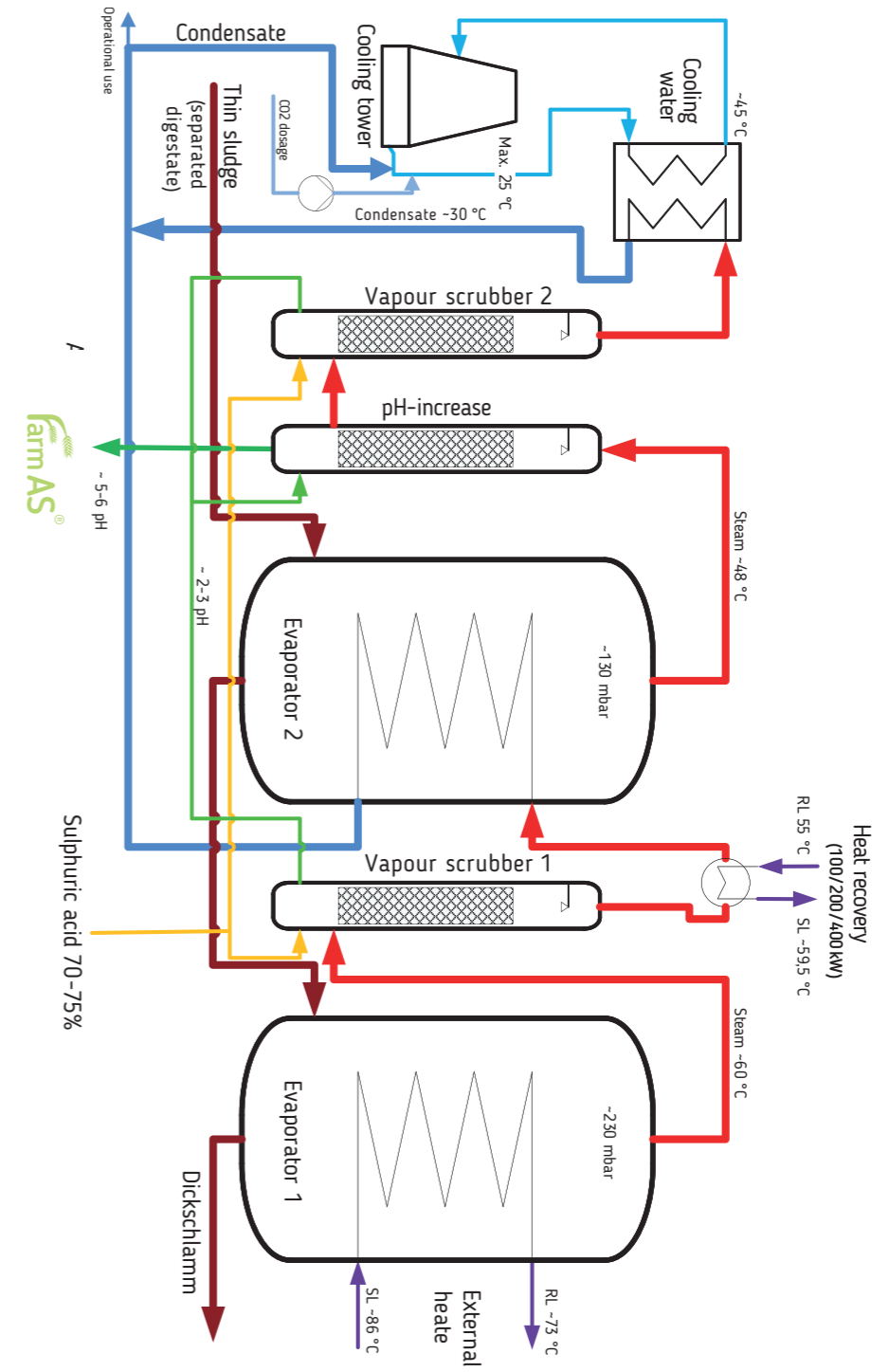

Performance and heat data 2-stage 500 kWh

Technical data	
Intake volume flow	up to 2500 l/h of digestate at 40 °C*
Dry matter content	max. 6 %
Particle size in digestate	< 0.5 mm
Concentration to dry matter content	up to 13 % **
	approx. 2.5 l/kWh th. ***
Distillate capacity	approx. 1,250 l/h ***
Distillate flow	86 °C
Flow temperature	73 °C
Return temperature	35.5 m3/h
Volumetric flow rate	950 mbar
Pressure loss, customer-side	2.5 bar
Pre-pressure, customer-side	water without glycol
Heat medium	16.5 x 4 x 6.4
Dimensions L x W x H (metres)	

* Digestate from biogas plants fed with agricultural feedstock

** With a dry matter concentration of more than 13 % to maximally possible 25 % dry matter, the performance data are lower.

*** The value is reduced accordingly when heat is extracted.

The performance data are based on a constant flow temperature and a maximum ambient air temperature of 27 °C.

Digestate evaporation, 2-stage, heat input 500 kW

Evaporation capacity of approx. 2.5 l per KW therm > 1250 l/h

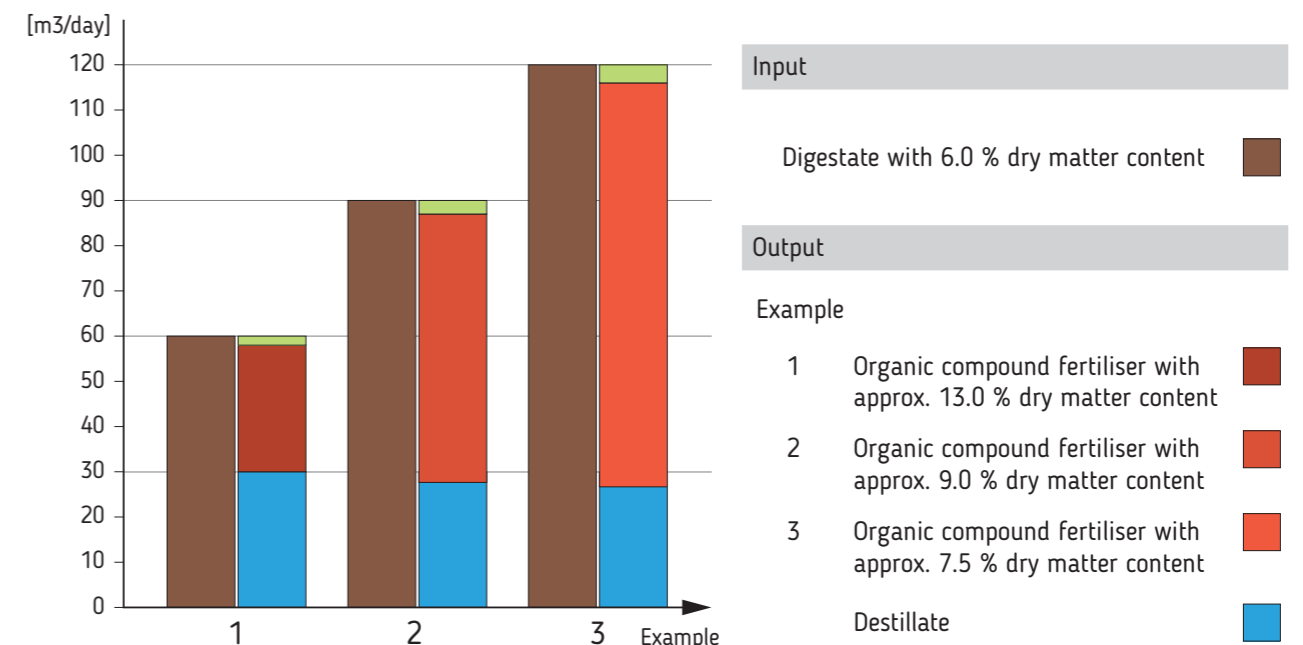

The absolute amount (m3) of the distillate is always relatively the same - no matter how much digestate enters the digestate evaporation system.

The percentage of farmAS® in relation to the input always remains relatively the same.



Vapogant products

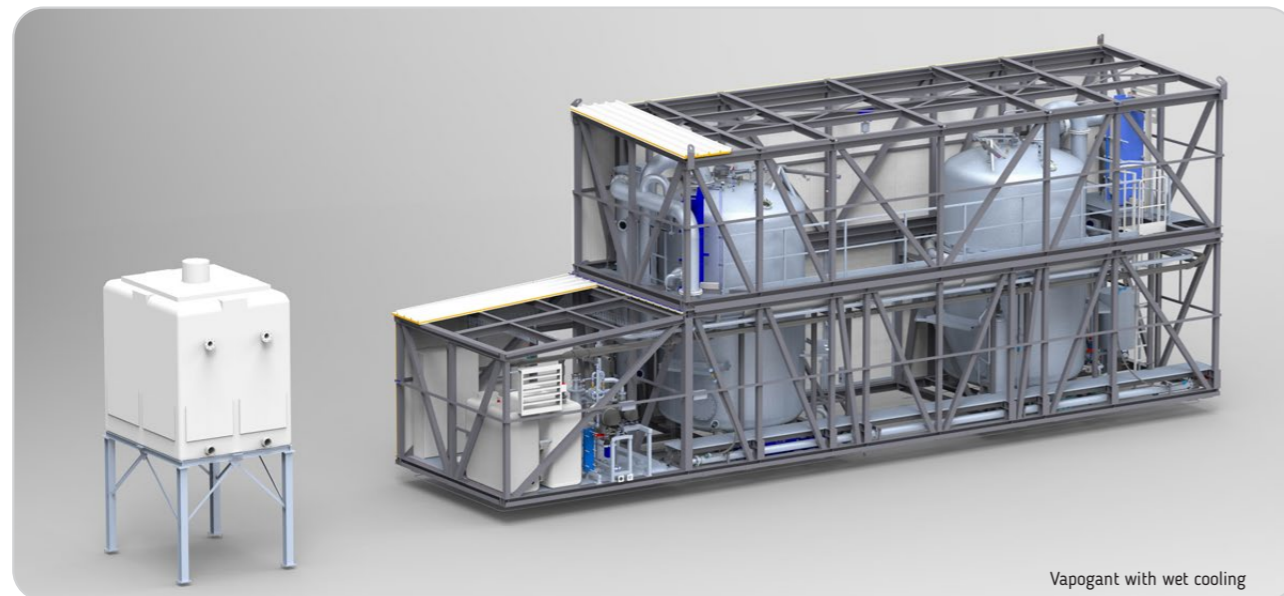

Exemplary analysis of condensate

	NO3-N	NH4-N	N total*	COD	BOD
[mg/l]	< 0.23	0.33	< 2	19	< 3.0

*measured as Total

Kjeldahl Nitrogen

Example analysis farmLC

	N org	NH4-N	N total	P2O5	K2O	MgO	S		DM
[kg/m³]	3.6	0.9	4.5	1.9	< 0.3	1.1	0.9	[%]	10.4
[kg/m³]	3.6	0.9	4.5	1.9	< 0.3	1.1	0.9	[%]	7

Example analysis farmAS®

	N	S	farmAS® (TS)	pH
[%]	8.52	8.8	40	6

Definitions:

farmAS® (ammonium sulphate)

Mineral commercial fertiliser from Vapogant

Nutrients: 8.5 % N, 9 % S

► Exceeds the minimum requirements of the Fertiliser Act

FarmLC® (liquid compost)

Composition CN ratio: 10:1

Production of mineral fertiliser using the VapoCircle® technology

PATENTED
GRV VAPOGANT: 11 2014 005 057.1

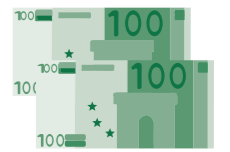
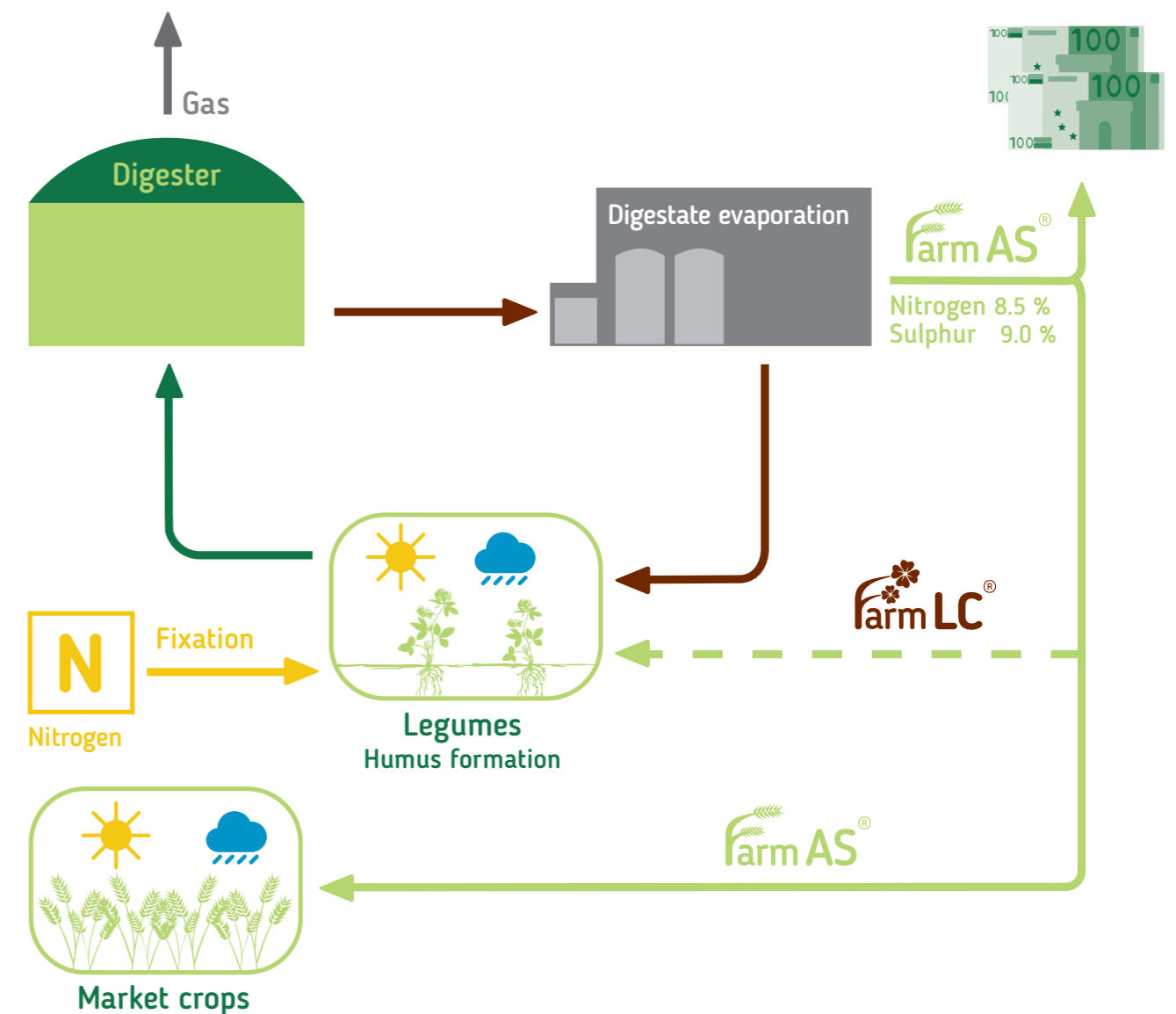

Spreading (CULTAN fertilisation)

The ammonium sulphate produced by the plant can be used further as customers see fit.

Direct addition to the digestate

The farmAS[®] is added to the digestate (thickened liquid phase) directly when spreading.



Application of farmAS[®] using CULTAN fertilisation

Function of depot spreading:

Application of the entire N requirement to the root zone of a crop.

- ▶ Ammonium can be spread as required or as a depot
- ▶ farmLC[®] can be spread irrespective of vegetation and crop
- ▶ Depot fertilisation makes use of nutrients not yet available in the soil

Different methods of depot spreading



CULTAN fertilisation



Strip Till
1) Fertiliser depot
2) Water depot
Source: Volmer Engineering

Storage farmAS[®]

farmAS[®] is stored not only in tanks but also in concrete containers.

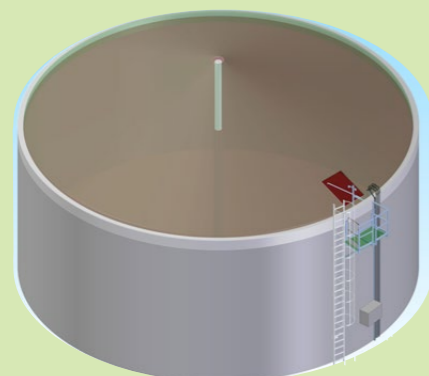

farmAS[®] storage pit in reinforced concrete round container - bird's eye view

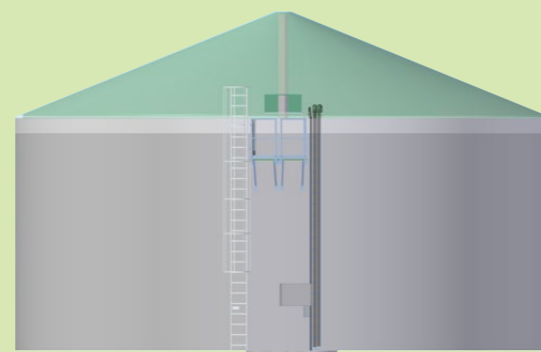

farmAS[®] storage pit in a reinforced concrete round container - front view



Crop farming advantages:

- ▶ **Sulphur fertilisation**
 - Kinsey method recommends 100-200 kg sulphur per ha per year
 - Improved humus formation thanks to increased activity of soil life
- ▶ **Protein formation in the plant**
Sulphur promotes protein content in crops
- ▶ **Lower nitrate values - nitrogen**
farmAS[®] contains 100 % ammonium nitrogen
- ▶ **Drought**
farmAS[®] does not need to be dissolved; immediately in the soil on the plant
- ▶ **Savings**
up to 20 % savings by reducing N losses through outgassing and washing out

CULTAN fertilisation:

- ▶ Application of the entire N requirement to the root zone of a crop
- ▶ Period: at the beginning or up to 4 weeks after the vegetation period
- ▶ Absorption of ammonium and protein build-up
- ▶ Protein metabolism
- ▶ Bound to clay minerals and humus in the soil
- ▶ No risk of washing out (low soil surface <1 %)
- ▶ Conversion of ammonium to nitrate from 5 °C
- ▶ **Soil temperature**
 - Absorption of ammonium N by the plant only in the amount of the current nitrogen requirement
 - No luxury consumption (as with KAS, nitrate)



Distillate use

Customers may use the vapour-cleaned distillate obtained from the evaporation process as needed:

Using the distillate for operational purposes

There are different options to use the distillate for operational purposes: Storing the water to be used as washing water for stables and areas, as thinning water for pesticides and liquid fertilisers, etc.

Evaporation of the distillate through the wet cooling tower

As a cooling unit is needed to operate the plant, part of the water may also be directly evaporated continuously through a cooling tower. Additionally, the cooled water is used as a cooling medium.

Indirect or direct distillate

introduction

The water is introduced continuously to a receiving stream, combined with an upstream distillate processing module if necessary.



Wet cooling tower

The wet cooling tower is an evaporative cooler that is operated with the condensate produced. It is used to lower the temperature in the cooling water circuit.



Dry cooler

The dry cooling tower is used when the condensate produced is completely re-utilised during operation. It is a closed system that is similar to the emergency cooler of the CHPS. It is used to lower the temperature in the cooling water circuit.



Stationary storage tank

Sulphuric acid store

Sulphuric acid is added to the process. It binds the ammonia and produces ammonium sulphate (farmAS®).

Built-in technology

Evaporator structure

Brushes and heating plates in the evaporator

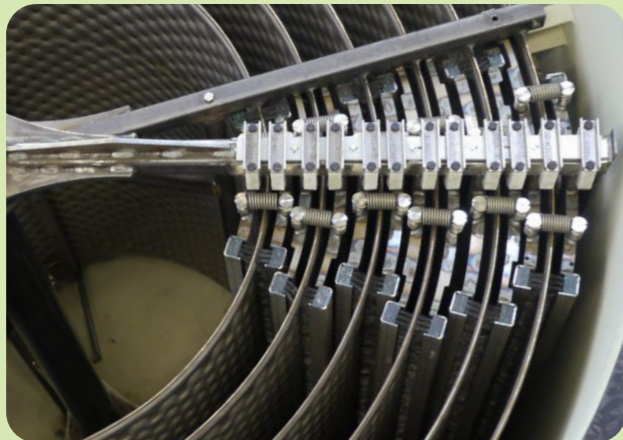
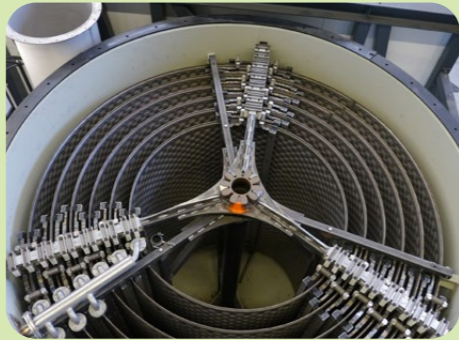

Arrangement of the cleaning brushes



Replaceable brush for cleaning

PATENTED
Brush for cleaning heating plates
EP3066187B1

Vapour scrubber



pH measurement in the vapour scrubber



Filling material in the vapour scrubber

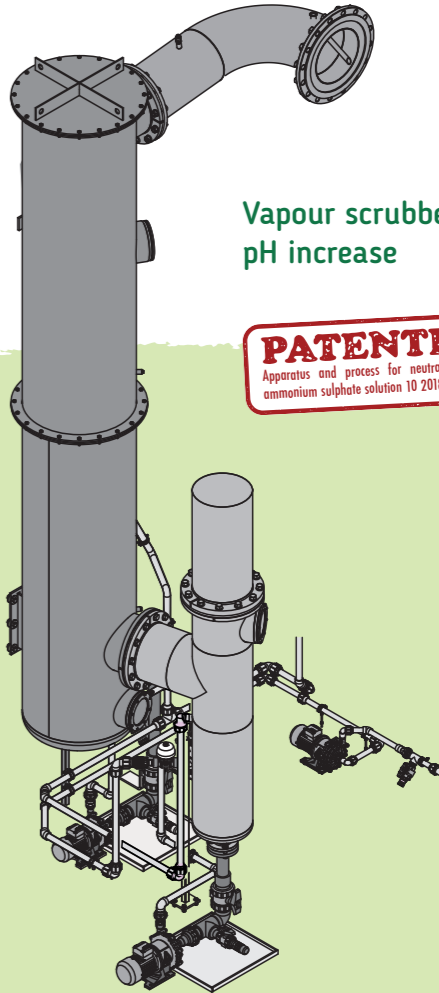

Vapour scrubber with pH increase

PATENTED
Apparatus and process for neutralising an ammonium sulphate solution 10 2018 120 720



Nozzle in the vapour scrubber



Vapour scrubber

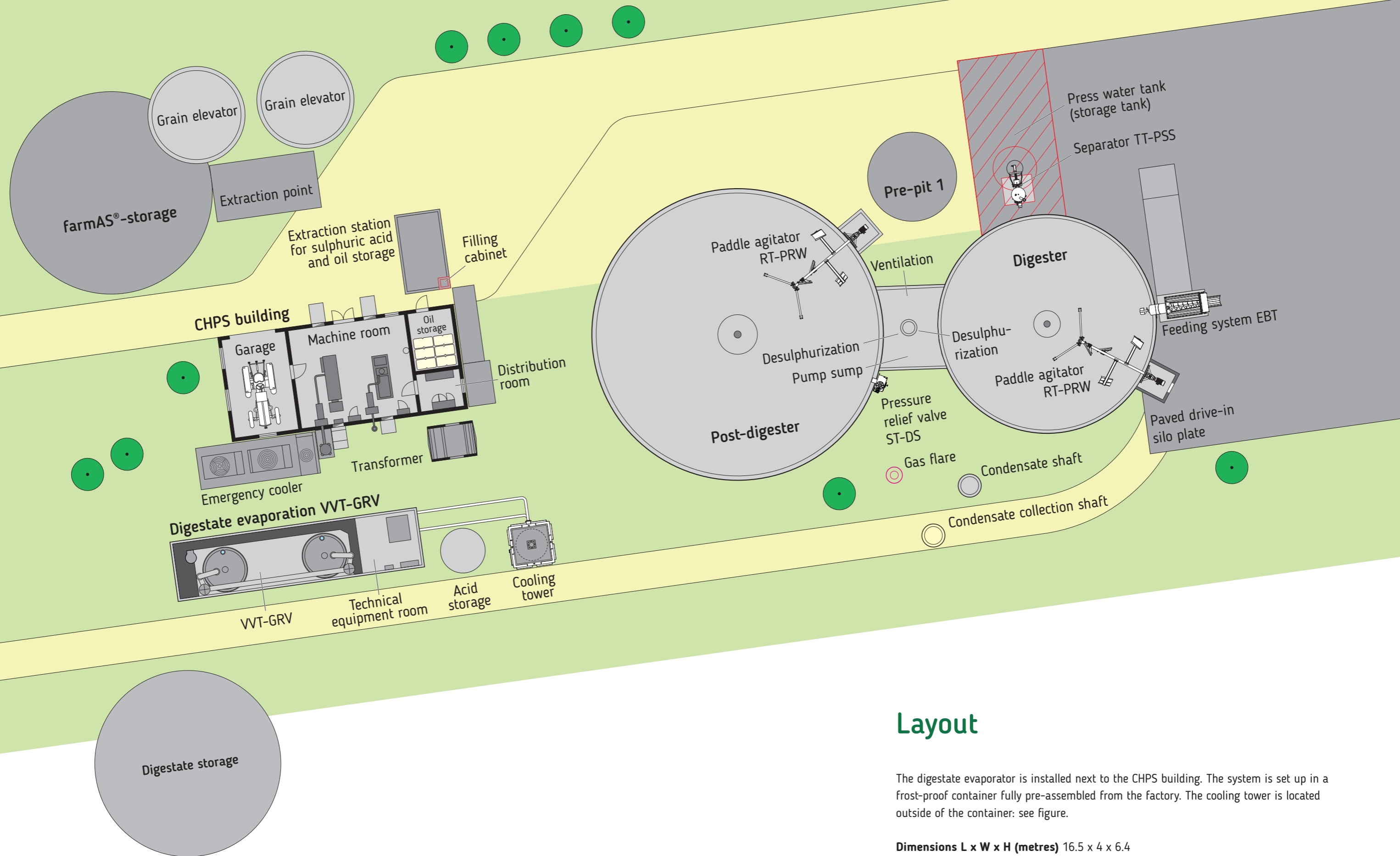

Layout

The digestate evaporator is installed next to the CHPS building. The system is set up in a frost-proof container fully pre-assembled from the factory. The cooling tower is located outside of the container: see figure.

Dimensions L x W x H (metres) 16.5 x 4 x 6.4



Legal note: This process description, including appendices, drawings and photos, is the property of Biogastechnik Süd GmbH, Isny. All rights reserved. All texts, images and graphics are protected by copyright and other laws for the protection of intellectual property. It is prohibited to copy or edit them either for trading purposes or for circulation.

Biogastechnik Süd GmbH

Am Schäferhof 2
D-88316 Isny im Allgäu

Telephone: +49 (0) 7562 / 970 85-40
Fax: +49 (0) 7562 / 970 85-50
E-mail: info@biogastechnik-sued.de

www.biogastechnik-sued.de

